

Artikel Nr.: 862234

Netzgerät, FLAT, CV, UT24V/20W











IP20 CE

Elektrische Daten

Betriebsart	spannungskonstant	Eingangsspannung	220-240V AC/50-60Hz
Leistung	20,00 W	Leistungsfaktor	0,94
Ausgangsspannung	24V DC	Anschlußmöglichkeit	Klemme
Ausgangsstrom	0-830 mA		

Produkteigenschaften

	Schutzklasse II		Überspannungsschutz
SELV	Schutzkleinspannung		Lampenbetriebsgerät 110
	Kurzschlußfest		Möbeleinbau geeignet
	Überlastschutz	ErP	Standby-Stromverbrauch < 0,5 W
	Übertemperaturschutz	LVD	Sicherheit nach EN 61347
	Sicherheitstrafo	EMC	Funkentstörung + Störfestigkeit nach EN 55015 + EN 61547
	nicht dimmbar	EMC	Netzstromoberwellen + Flicker nach EN 61000-3-2 + EN 61000-3-3

Schwarze Felder sind zutreffend / graue Felder sind nicht zutreffend

Artikel Nr.: 862234

Netzgerät, FLAT, CV, UT24V/20W

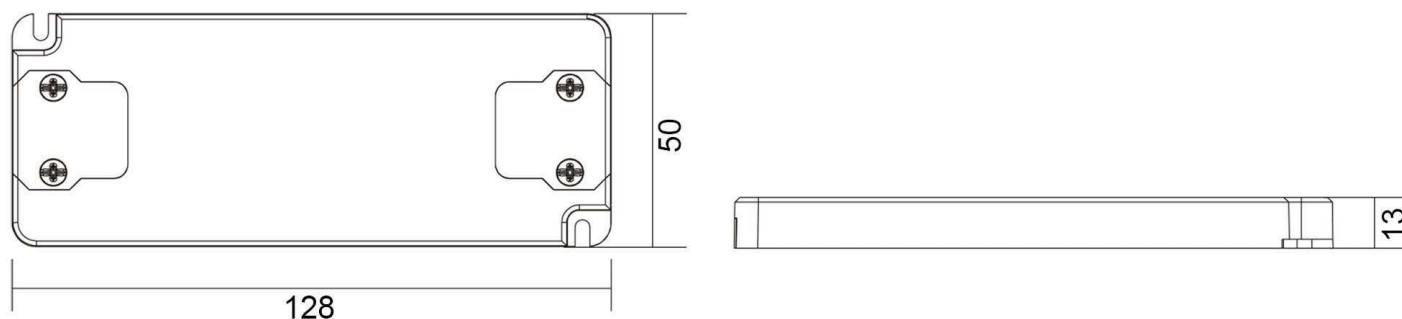

Abmessungen und Gewicht

Grenzwerte

Länge	128,00 mm	Betriebstemperatur	-20°C - +50°C
Breite	50,00 mm	Gehäusetemperatur	0 °C
Höhe	13,00 mm	max. Menge Sicherungsautomaten	B10A=35, B16A=56, C10A=70, C16A=112
Durchmesser	0,00 mm	max. Einschaltstrom	20A/100µs
Gewicht	g	kapazitive Last	446µf

Article No.: 862234

Power supply unit, FLAT, CV, UT24V/20W











IP20 CE

Electrical Characteristics

Operating mode	constant voltage	Input voltage	220-240V AC/50-60Hz
Power	20,00 W	Power factor	0,94
Output voltage	24V DC	Connection possibility	clamp
Output current	0-830 mA		

Product features

	Protection class II		Overvoltage protection
SELV	Low voltage protection		Lamp control gear 110
	Short circuit protection		Suitable for furniture installation
	Overload protection	ErP	Standby-power consumption < 0,5 W
	Overheating protection	LVD	Safety according to EN 61347
	Safety transformer	EMC	Interference suppression + immunity according to EN 55015 + EN 61547
	not dimmable	EMC	Mains harmonics + flicker according to EN 61000-3-2 + EN 61000-3-3

Black fields are applicable / gray fields are not applicable

Article No.: 862234

Power supply unit, FLAT, CV, UT24V/20W

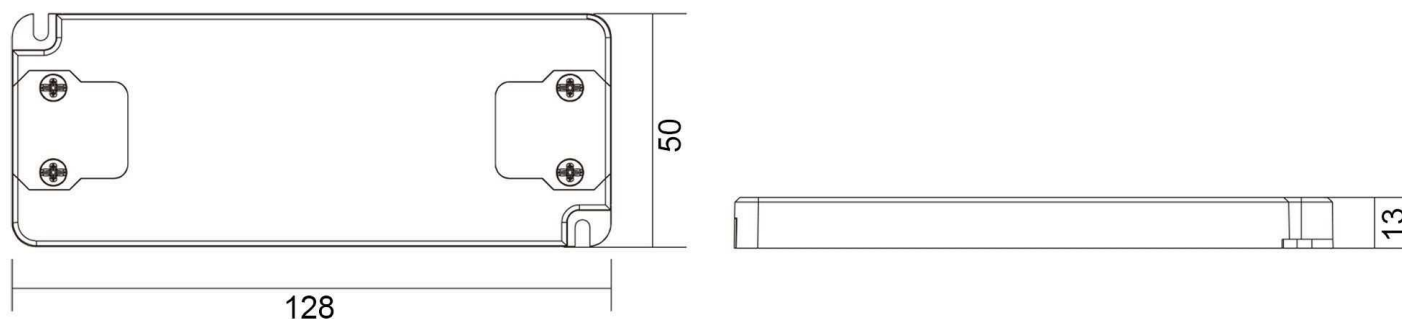
**Dimensions & Weight****Absolute maximum ratings**

Length	128,00 mm	Operating temperature	-20°C - +50°C
Width	50,00 mm	Case temperature	0 °C
Height	13,00 mm	max. amount of circuit breakers	B10A=35, B16A=56, C10A=70, C16A=112
Diameter	0,00 mm	max. inrush current	20A/100µs
Product weight	g	capacitive load	446µf