

Artikel Nr.: 862223

Netzgerät, FLAT, CC, UT350mA/12W



IP20 CE

Elektrische Daten

Betriebsart	stromkonstant	Eingangsspannung	220-240V AC/50-60Hz
Leistung	0,70-12,00 W	Leistungsfaktor	0,92
Ausgangsspannung	2-35V DC	Anschlußmöglichkeit	Klemme
Ausgangsstrom	350 mA		

Produkteigenschaften

	Schutzklasse II		Überspannungsschutz
SELV	Schutzkleinspannung		Lampenbetriebsgerät 110
	Kurzschlußfest		Möbeleinbau geeignet
	Überlastschutz	ErP	Standby-Stromverbrauch < 0,5 W
	Übertemperaturschutz	LVD	Sicherheit nach EN 61347
	Sicherheitstrafo	EMC	Funkentstörung + Störfestigkeit nach EN 55015 + EN 61547
	nicht dimmbar	EMC	Netzstromoberwellen + Flicker nach EN 61000-3-2 + EN 61000-3-3

Schwarze Felder sind zutreffend / graue Felder sind nicht zutreffend

Artikel Nr.: 862223

Netzgerät, FLAT, CC, UT350mA/12W

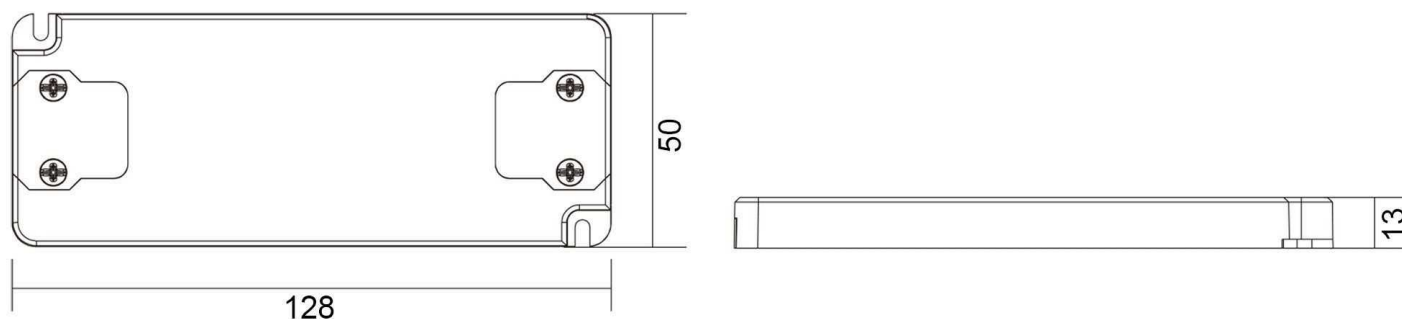

Abmessungen und Gewicht

Grenzwerte

Länge	128,00 mm	Betriebstemperatur	-20°C - +50°C
Breite	50,00 mm	Gehäusetemperatur	0 °C
Höhe	13,00 mm	max. Menge Sicherungsautomaten	B10A=70, B16A=112, C10A=111, C16A=177
Durchmesser	0,00 mm	max. Einschaltstrom	10A/100us
Gewicht	g	kapazitive Last	194uF

Article No.: 862223

Power supply unit, FLAT, CC, UT350mA/12W



IP20 CE

Electrical Characteristics

Operating mode	constant current	Input voltage	220-240V AC/50-60Hz
Power	0,70-12,00 W	Power factor	0,92
Output voltage	2-35V DC	Connection possibility	clamp
Output current	350 mA		

Product features

	Protection class II		Overvoltage protection
SELV	Low voltage protection		Lamp control gear 110
	Short circuit protection		Suitable for furniture installation
	Overload protection	ErP	Standby-power consumption < 0,5 W
	Overheating protection	LVD	Safety according to EN 61347
	Safety transformer	EMC	Interference suppression + immunity according to EN 55015 + EN 61547
	not dimmable	EMC	Mains harmonics + flicker according to EN 61000-3-2 + EN 61000-3-3

Black fields are applicable / gray fields are not applicable

Article No.: 862223

Power supply unit, FLAT, CC, UT350mA/12W

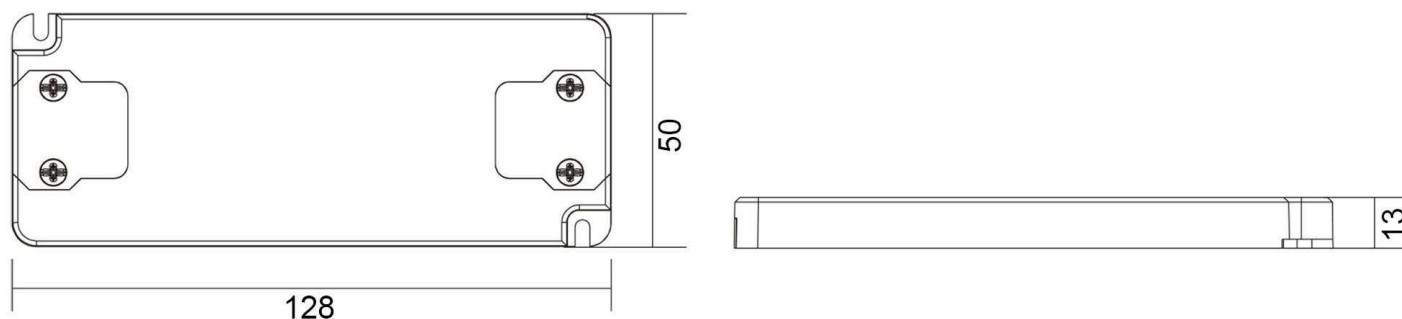
**Dimensions & Weight****Absolute maximum ratings**

Length	128,00 mm	Operating temperature	-20°C - +50°C
Width	50,00 mm	Case temperature	0 °C
Height	13,00 mm	max. amount of circuit breakers	B10A=70, B16A=112, C10A=111, C16A=177
Diameter	0,00 mm	max. inrush current	10A/100us
Product weight	g	capacitive load	194uF