

Artikel Nr.: 862132

Netzgerät, FLAT, CC, UT500mA/20W











IP20 CE

Elektrische Daten

Betriebsart	stromkonstant	Eingangsspannung	220-240V AC/50-60Hz
Leistung	1,00-20,00 W	Leistungsfaktor	0,55
Ausgangsspannung	2-40V DC	Anschlußmöglichkeit	Klemme
Ausgangsstrom	500 mA		

Produkteigenschaften

	Schutzklasse II		Überspannungsschutz
SELV	Schutzkleinspannung		Lampenbetriebsgerät 110
	Kurzschlußfest		Möbeleinbau geeignet
	Überlastschutz	ErP	Standby-Stromverbrauch < 0,5 W
	Übertemperaturschutz	LVD	Sicherheit nach EN 61347
	Sicherheitstrafo	EMC	Funkentstörung + Störfestigkeit nach EN 55015 + EN 61547
	nicht dimmbar	EMC	Netzstromoberwellen + Flicker nach EN 61000-3-2 + EN 61000-3-3

Schwarze Felder sind zutreffend / graue Felder sind nicht zutreffend

Artikel Nr.: 862132

Netzgerät, FLAT, CC, UT500mA/20W

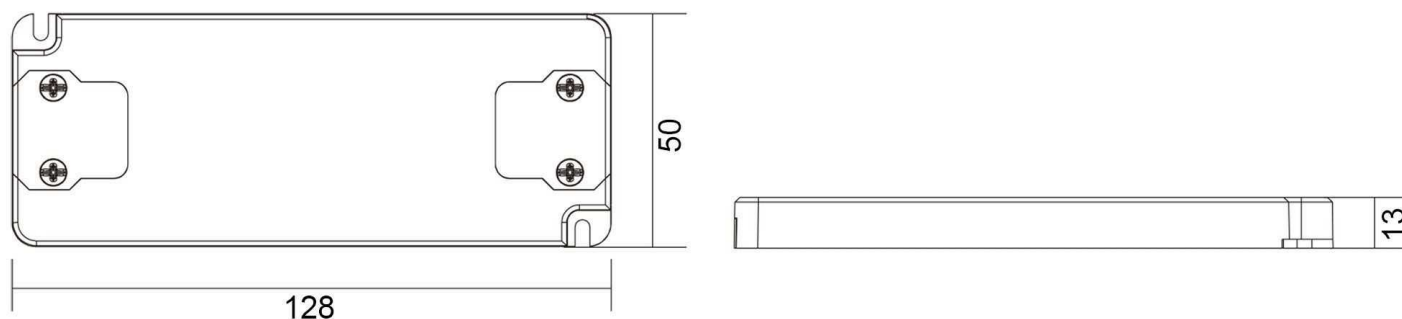
**Abmessungen und Gewicht****Grenzwerte**

Länge	128,00 mm	Betriebstemperatur	-20°C - +50°C
Breite	50,00 mm	Gehäusetemperatur	85 °C
Höhe	13,00 mm	max. Menge Sicherungsautomaten	B10A=11, B16A=18, C10A=24, C16A=39
Durchmesser	0,00 mm	max. Einschaltstrom	15A/300µs
Gewicht	73 g	kapazitive Last	192,6nF

Article No.: 862132

Power supply unit, FLAT, CC, UT500mA/20W











IP20 CE

Electrical Characteristics

Operating mode	constant current	Input voltage	220-240V AC/50-60Hz
Power	1,00-20,00 W	Power factor	0,55
Output voltage	2-40V DC	Connection possibility	clamp
Output current	500 mA		

Product features

	Protection class II		Overvoltage protection
SELV	Low voltage protection		Lamp control gear 110
	Short circuit protection		Suitable for furniture installation
	Overload protection	ErP	Standby-power consumption < 0,5 W
	Overheating protection	LVD	Safety according to EN 61347
	Safety transformer	EMC	Interference suppression + immunity according to EN 55015 + EN 61547
	not dimmable	EMC	Mains harmonics + flicker according to EN 61000-3-2 + EN 61000-3-3

Black fields are applicable / gray fields are not applicable

Article No.: 862132

Power supply unit, FLAT, CC, UT500mA/20W

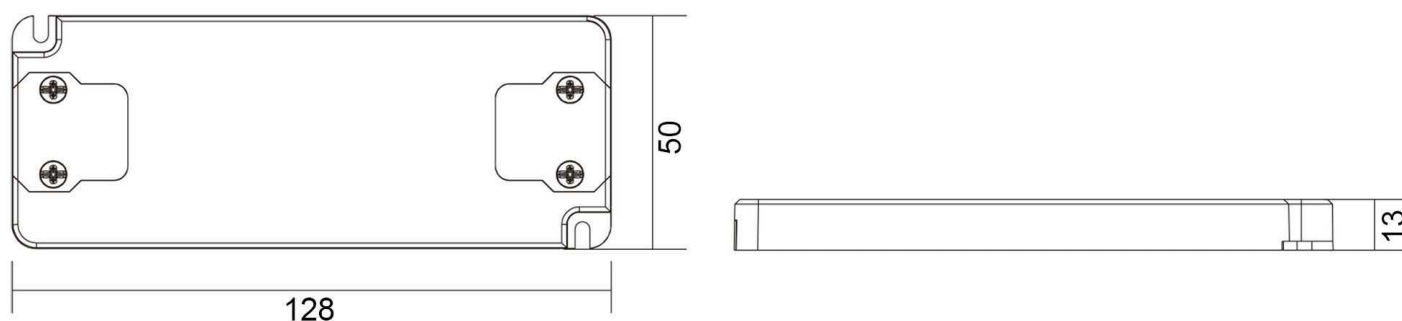
**Dimensions & Weight****Absolute maximum ratings**

Length	128,00 mm	Operating temperature	-20°C - +50°C
Width	50,00 mm	Case temperature	85 °C
Height	13,00 mm	max. amount of circuit breakers	B10A=11, B16A=18, C10A=24, C16A=39
Diameter	0,00 mm	max. inrush current	15A/300µs
Product weight	73 g	capacitive load	192,6nF